

CR1616

3V Lithium Battery
Swiss Made

Technical Data Sheet

Specifications

Chemical System	Li / MnO ₂
Nominal Voltage	3 V
Rated Capacity	50 mAh
Standard Discharge Current	0.1 mA
Max. Cont. Discharge Current	1.0 mA
Average Weight	1.1 g
Operating Temperature*	-40 - +85 °C
Self Discharge at 23°C	< 1% / year

Dimensions

(According to IEC 60086)

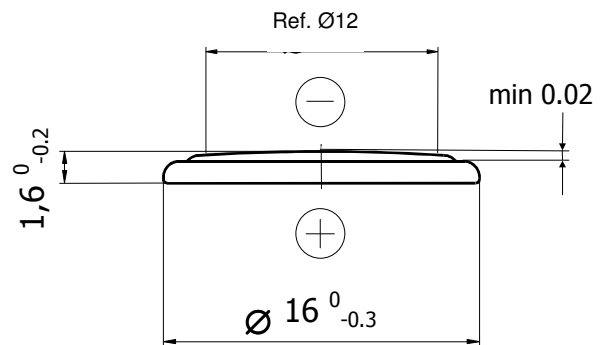

Performance

Discharge performance at 23°C

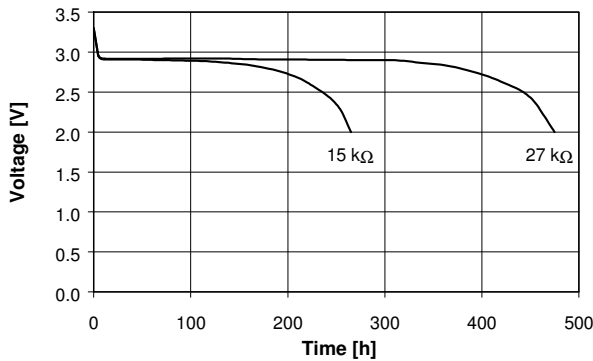

Discharge performance at 23°C

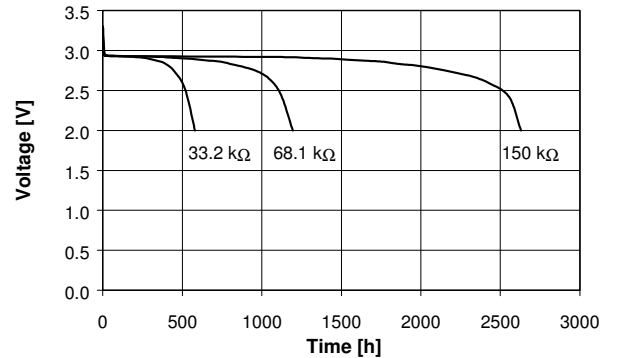

Temperature performance Load 27kΩ

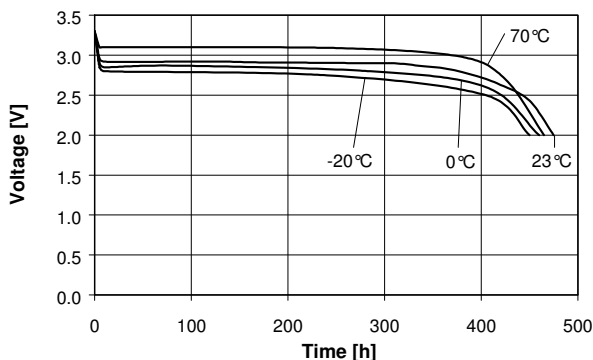

Cell capacity at various loads

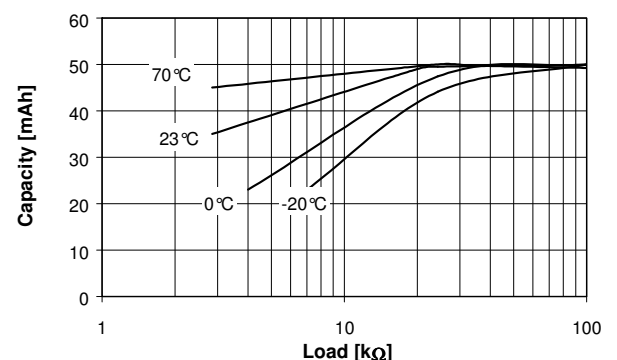

*In applications where the battery is exposed to temperatures above 70 °C, please contact Renata for consultancy.

Information and contents in this data sheet are for reference purpose only. They do not constitute any warranty or representation and are subject to change without notice. For most current information and further details, please contact your Renata representative.